



TT 34

MICROPROCESSOR-BASED DIGITAL ELECTRONIC TIMER



User Manual

Cod.: ENG - Vr. 03 - 17/05 - ISTR-MTT34E03

ASCONECNOLOGIC S.r.l.

Viale Indipendenza 56, 27029 - VIGEVANO (PV) ITALY

TEL.: +39 0381 69871 - FAX: +39 0381 698730

http://www.ascontecnologic.com

e-mail: info@ascontecnologic.com

PREFACE

 This manual contains the information necessary for the product to be installed correctly and also instructions for its maintenance and use; we therefore recommend that the utmost attention is paid to the following instructions and to save it.

This document is the exclusive property of Ascon TecnoLogic S.r.l. which forbids any reproduction and divulgation, even partially, of the document, unless expressly authorized.

Ascon TecnoLogic S.r.l. reserves the right to make any formal or functional changes at any moment and without any notice. Ascon TecnoLogic S.r.l. and its legal representatives do not assume any responsibility for any damage to people, things or animals deriving from violation, wrong or improper use or in any case not in compliance with the instrument features.

 Whenever a failure or a malfunction of the device may cause dangerous situations for persons, thing or animals, please remember that the plant has to be equipped with additional devices which will guarantee safety.

Index

1. Instrument description	1
1.1 General description.....	1
1.2 Front panel description	2
2. Programming	2
2.1 Set points programming.....	2
2.2 Parameters programming	2
2.3 Parameters Lock.....	2
3. Installation and use warnings	2
3.1 Allowed Usage	2
3.2 Mechanical Mounting.....	2
3.3 Electrical connections	3
3.4 Electrical connection diagram	3
4. Operating mode	3
4.1 Operating commands.....	3
4.2 Display functioning.....	3
4.3 OUT1 Operating mode.....	4
4.4 OUT2 Operating mode.....	4
4.5 CNT EN Input operating mode.....	5
5. Programmable parameters	6
5.1 Parameters table.....	6
5.2 Parameters description	6
6. Problems, maintenance and warranty	7
6.1 Cleaning.....	7
6.2 Warranty and repairs.....	7
6.3 Disposal	7
7. Technical data	7
7.1 Electrical data	7
7.2 Mechanical data.....	7
7.3 Functional data	7
8. Instrument ordering code	8

1. INSTRUMENT DESCRIPTION

1.1 General description

TT 34 is a programmable microprocessor based timer with 1 or 2 outputs.

The instrument offers the possibility to program: up to 3 set Point times, 5 operating modes for the output **OUT1**, 4 operating modes for the output **OUT2**, 4 time scales (from 9999 h maximum to 0.1 s minimum), 4 functioning modes of counting enable and 2 counting modes (**UP/DOWN**).

The instrument can be connected to an external back up battery (9 V) which permits the counting also without power supply. The counting state is displayed on a 4 digits display while the outputs state is indicated by LEDs.

The instrument can have 2 outputs (relay or voltage output to drive solid state relays) and 2 digital inputs for free of voltage contacts or voltage inputs (the same voltage supply value). The 2 digital inputs are used to enable counting (**CNT EN**) and reset (**RES**).

The instrument can be programmed using the keys placed on the front panel while the Start count command can be submitted with the key  or using the digital inputs **CNT EN** and **RES** connected in the back of the instrument.

1.2 Front panel description

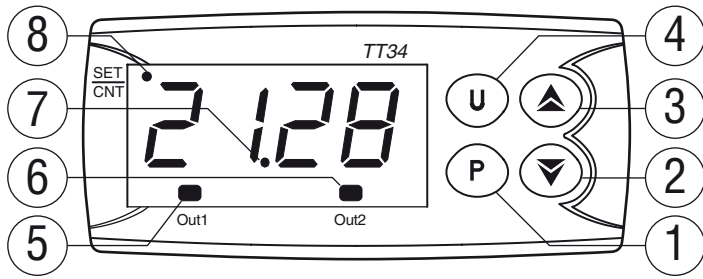

1. **P**: Used for the set point setting and to program the functioning parameters
2. **▼**: Used to decrease the values or to select parameters
3. **▲**: Used to increase the values or to select parameters
4. **U**: Used to Start, Stop or reset the count
5. LED OUT1: Indicates when the output **OUT1** is **ON** or **OFF**.
6. LED OUT2: Indicates when the output **OUT2** is **ON** or **OFF**.
7. LED Separator: Indicates the separation between hours and minutes, minutes and seconds or seconds and cents.
8. LED SET/CNT: Indicates the set point or the **parameters programming mode** (flashing fast), the **count ON** (flashing each second), the **count stopped** (ON) or **reset mode** (OFF).

2. PROGRAMMING

2.1 Set points programming

The instrument allows to program up to 3 time sets: t_1 , t_2 , t_3 . To program this times proceed as follows:

- Stroke the **P** key and keep it pushed for about 1 s, the display shows t_1 and LED SET/CNT blinks rapidly. When the **P** key is released, the display shows alternatively t_1 and the value programmed for time t_1 . To modify the t_1 value, press the **▲** key to increase it or the **▼** key to decrease it.
- If the selected operating mode requires to set the t_2 time ($F_1 = 3, 4$ or 5), press the **P** key again (within 5 s), the display shows t_2 . When the **P** key is released, the display shows alternatively t_2 and its value. To modify the t_2 time value, use the keys **▲** or **▼**.
- If the selected operating mode requires to set the t_3 time ($F_2 = 3$ or 4), press the **P** key again (within 5 s), the display shows t_3 . When the **P** key is released, the display shows alternatively t_3 and its value. To modify the t_3 time value, use the keys **▲** or **▼**.

To exit the Times programming mode, press no keys for about 5 s or press the **U** key once, the timer returns to the counting value. The programming of the set times is always possible, both with counting ON or OFF.

2.2 Parameters programming

To have access at the functioning parameters, press the **P** key and keep it pressed for about 5 s at the end of which the timer shows the label of the first programmable parameter F_1 . Releasing the **P** key the instrument shows alternatively the label F_1 and the value programmed for t_1 which can be modified with the **▲** or **▼** keys. Once the desired value has been programmed, press the **P** key again, the instrument shows the label of the next parameter.

Releasing the **P** key, t_1 appears the value programmed for that parameter which can be modified using the **▲** or **▼** keys. Pushing and releasing key **P** it is possible to scroll all the

parameters labels (when the **P** key is pushed) and the relative programming (when the **P** key is released) one after the other. To exit the parameters programming mode, press **NO KEYS** for about 20 s, or press the **U** key once, the timer returns to the counting value.

Note: While the timer is running, it is not possible to enter the parameters programming mode.

2.3 Parameters Lock

It is possible to lock the access at the programming parameters using the following procedure :

- Switch OFF the instrument, press key **P** and keep it pressed while the instrument is powered ON again.
- After about 3 s on the display appears the software release number, the after 2 s on the display appears UL (unlock) that indicates that the parameters are accessible.
- While the **P** key is pressed, press also the **▼** key, the instrument displays L (lock) to specify that the parameters are not accessible.
- Release key **P** to exit from this procedure.
- The display returns to the normal functioning, the parameters will not be accessible anymore and it will only be possible to modify the Set Points.
- To access the parameters again, repeat the same procedure pressing again the **▼** key to select UL ; at the end exit the parameters lock modality.

3. INSTALLATION AND USE WARNINGS

3.1 Allowed Usage



The instrument has been projected as measure and control device, built according to EN61010-1 for the altitudes operation until 2000 ms.

The use of the instrument for applications not explicitly allowed by the above mentioned rule has to foresee proper protection devices.

The instrument **MUST NOT** be used in environments with dangerous atmosphere (flammable or explosive) without a proper protection.

It has to be reminded that the user has to take care that the electromagnetic rules are being respected also after the instrument installing, eventually using proper filters.

3.2 Mechanical Mounting

The instrument, in case 33 x 75 mm, is designed for flush-in panel mounting. Make a hole 29 x 71 mm and insert the instrument, fixing it with the provided special bracket(s).

We recommend to mount the gasket to obtain the front protection degree as declared.

Instrument dimensions

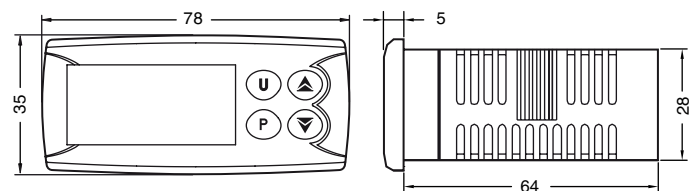

Panel cutout

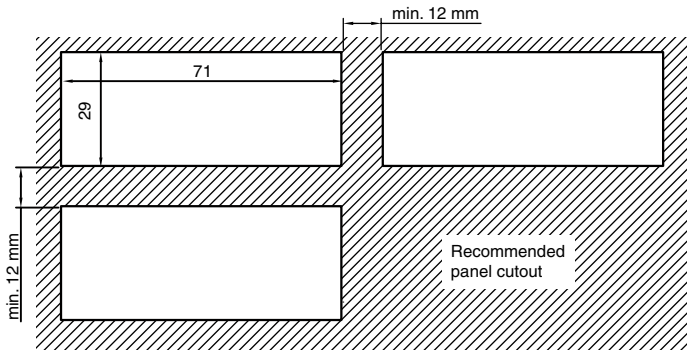

Mounting brackets

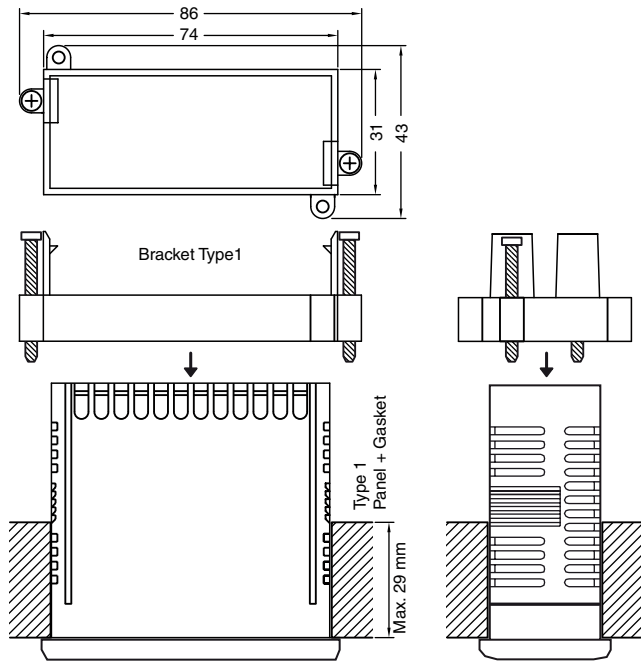

Avoid to install the instrument in places with very high humidity or dirt that may create condensation or introduction into the instrument of conductive substances.

Ensure the adequate ventilation to the instrument and avoid the installation within boxes where are placed devices which may overheat or have as a consequence the instrument functioning at temperature higher than allowed and declared.

Connect the instrument as far as possible from source of electromagnetic disturbances so as motors, power relays, relays, electrovalves, etc..

3.3 Electrical connections

Carry out the electrical wiring connecting only one wire for each terminal, according to the following diagram, checking that the power supply is the same as indicated on the instrument and the loads current is not higher than the maximum current admitted.

The instrument, being a built in equipment with permanent connection into a cabinet, is not equipped neither with switches nor with internal devices protecting it from overcurrents: it is therefore recommended to provide for the installation of a two-phase circuit-breaker placed as near as possible to the instrument, located in a position easily reachable by the user and marked as instrument disconnecting device. It is furthermore recommended to properly protect all the electric circuits connected to the instrument, with devices (ex. fuses) proportionate to the circulating currents.

It is strongly recommended to use cables with proper insulation, according to the working voltages and temperatures and to separate the control signal cables from the line voltage wiring.

When you choose the b parameter with option 2 (timer continues operating in case of power failure) is necessary to connect the external battery.

With the purpose to prolong its duration, disconnect the battery when it is not necessary to the operation.

Finally, it is advisable to check that the parameters are those desired before connecting the outputs to the actuators in order to avoid plant anomalies which may cause injuries to people, things or animals.

3.4 Electrical connection diagram

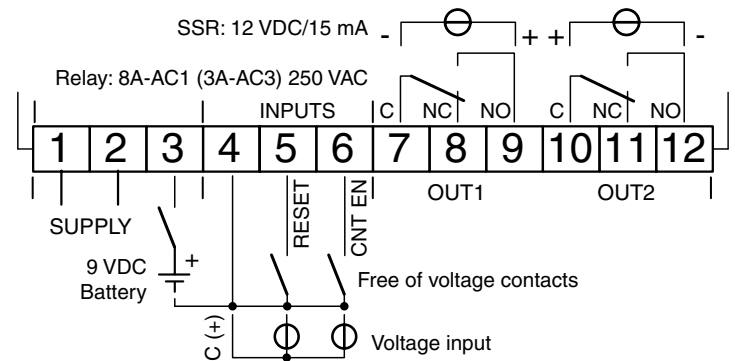

4. OPERATING MODE

4.1 Operating commands

The counting can be enabled and disabled through the \odot key or through the remote inputs **CNT EN** and **RES**.

The operating mode of the \odot key is defined by the parameter "L", the operating mode of the input **CNT EN** is defined by the parameter "E" while the **RES** input always works as **reset**, i.e. it stops and resets the counting when is active and moreover it has the priority on the other commands (when **RES** is activated it does not allow the count Start).

When the installation is planned to allow the timer functioning during the power failures, during the power down conditions the only active command is the **RESET** that can be submitted using the \odot key. When the instrument is supplied through the battery, it is not therefore possible re-start the counting once it has been stopped.

4.2 Display functioning

The LED **SET/CNT** is used to indicate the access in **programming mode** (flashing fast), the **count in action** (flashing each second), the **count interrupted before the term** (lighted fixed) or the **count finished** and **RESET status** (OFF).

After the Reset, the display shows $\square\square\square\square$ when the counting mode is programmed as **UP** (parameter $L = 1$) or displays the programmed time value if the counting mode is programmed as **DOWN** (parameter $L = 2$).

While the timer is functioning, the display shows the value of the elapsed time in **UP** or in **DOWN** mode.

If the back-up mode has been programmed to continue the counting in action in case of power failure, the display remains lighted but with at low brightness (with the purpose to limit as much as possible the battery consumption).

4.3 OUT1 Operating mode

The instrument can be programmed by the parameter $F1$ to operate in any of the following 5 modes:

F1 = 1 Delayed:

Timing begins at the leading edge of the **Start** signal. The control output **OUT1** will be energized when the present value equals the $t1$ preset time. The output is sustained until a **RESET** signal is applied.

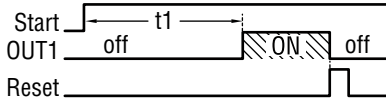

F1 = 2 Feedthrough:

Timing begins at the leading edge of the **Start** signal. The control output **OUT1** is energized only during timing (the output is disabled when the set time value $t1$ has been reached). The output will be enabled again after a **RESET** and a subsequent **START** signals have been received.

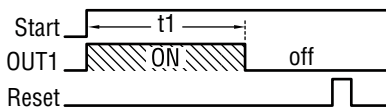

F1 = 3 Asymmetrical oscillator with start in ON:

This operating mode allows the user to enter two Set times $t1$ and $t2$, and therefore also involves the $S2$ parameter. The **ON/OFF cycle** is initiated at the leading edge of the **Start** signal. The control output **OUT1** is immediately enabled and remains **ON** for the $t1$ preset time, then the output is disabled and remains disabled for the time period $t2$. This procedure continues until a **RESET** signal is received.

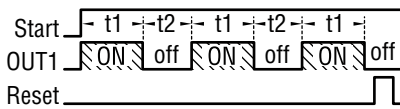

F1 = 4 Asymmetrical oscillator with start in OFF:

This operating mode allows the user to enter two Set times $t1$ and $t2$, and therefore also involves the $S2$ parameter. The **OFF/ON cycle** is initiated at the leading edge of the **Start** signal. The control output **OUT1** remains **OFF** (disabled) for the $t1$ preset time, then **OUT1** is enabled and remains **ON** (enabled) for the time period $t2$. This procedure continues until a **RESET** signal is received.

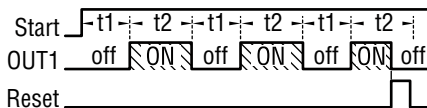

F1 = 5 One cycle asymmetrical oscillator with start in OFF:

The operation is similar to the previous one (F1 = 4) with the only difference that **only one cycle** of **OFF/ON** is performed. The **OFF/ON cycle** is initiated at the leading edge of the **Start** signal. The control output **OUT1** remains **OFF** (disabled) for the $t1$ preset time, then **OUT1** is enabled and remains **ON** (enabled) for the time period $t2$. The cycle will be enabled again after a **RESET** and a subsequent **START** signals have been received.

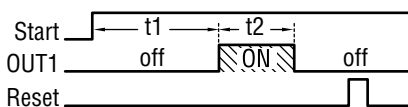

4.4 OUT2 Operating mode

The instrument can be programmed by the parameter $F2$ to operate in any of the following 4 modes:

F2 = 1 Output **OUT2** operates like **OUT1**:

Output **OUT2** operates in the same way as output **OUT1** in order to give the user two output contacts.

F2 = 2 Output **OUT2** operates as an instant contact:

OUT2 is activated during the counting phase and remains active until a **RESET** signal is received.

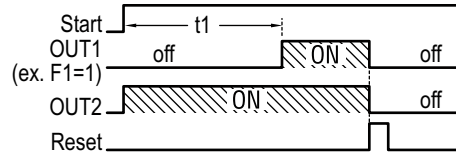

F2 = 3 Same function of **OUT1** (time $t1$) with time $t3$ absolute:

The choice of this mode of operation enables the Set time $t3$ that has the same $S1$ range time and cannot be higher than $t1$. Timing begins at the leading edge of the **Start** signal, the instrument operates on output **OUT2** in the same way $F1$ operates on the output **OUT1**. If $F1 = 1, 4$ or 5 output **OUT2** operates with Delayed function: is enabled when $t3$ is expired while if $F1 = 2$ or 3 output **OUT2** operates with feedthrough function: is immediately enabled and disabled at the end of time $t3$. While programming the $t3$ time the display shows $t3 \bar{c}$ ($t3 i$) to indicate that the time $t3$ is independent.

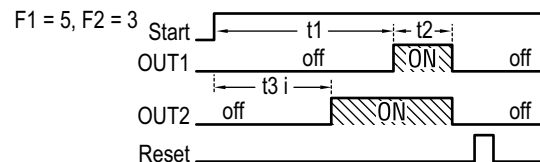
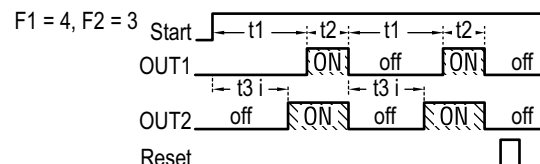
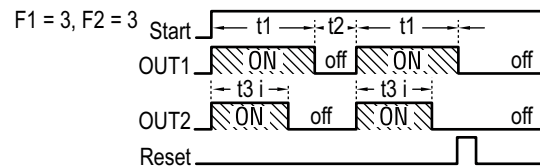
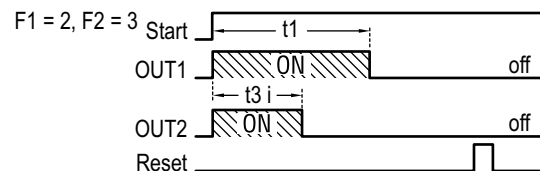
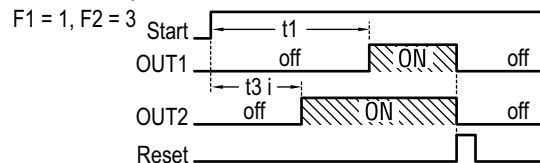

F2 = 4 Same function of **OUT1** (time t_1) with time t_3 relative to t_1 (in advance):

The choice of this mode of operation enables the Set time t_3 that has the same S_1 range time and cannot be higher than t_1 . Timing begins at the leading edge of the **Start** signal, the instrument operates on output **OUT2** in the same way F_1 operates on the output **OUT1**.

If $F_1 = 1, 4$ or 5 output **OUT2** operates with Delayed function with the time $[t_1 - t_3]$ while if $F_1 = 2$ or 3 output **OUT2** operates with feedthrough function with the time $[t_1 - t_3]$. While programming the t_3 time the display shows $t_3 d$ ($t_3 d$) to indicate that the time t_3 depends on the value of t_1 .

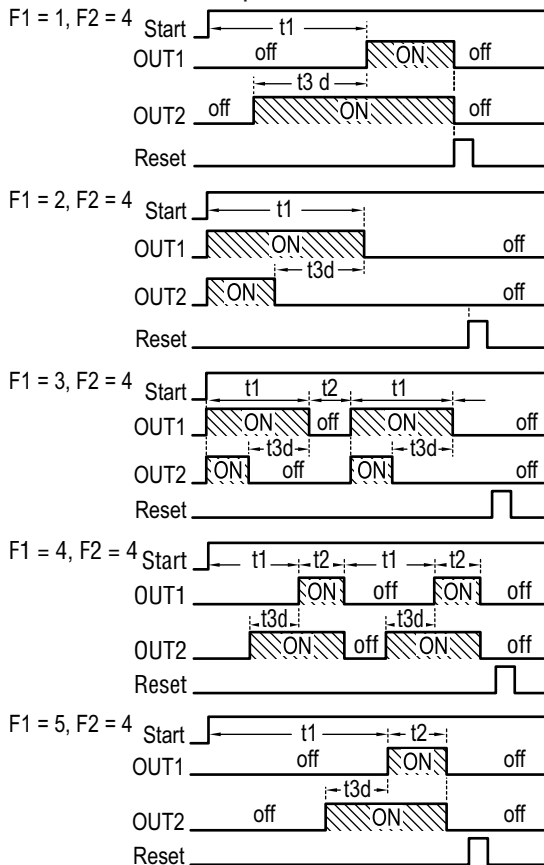

If $F_2 = 0$ the output **OUT2** is always disabled.

4.5 CNT EN Input operating mode

The Start signal can be given by the \odot key programmed as **START/STOP** ($t = 1$ or 2), which normally has a bistable functioning, or by the count enable digital input (**CNT EN**).

The **CNT EN** input can be programmed to operate in any of the following 4 modes:

E = 1 - Bistable (toggle) **START/STOP**:

After resetting the timer using the **RESET** input, close the **CNT EN** contact to **start** the timer. Now release the contact. When the contact is closed again, the timer stops on the current counting value. The timer starts again at the next closure of the **CNT EN** input port. This procedure goes on until a **RESET** signal is received or the **set time** period has **expired**.

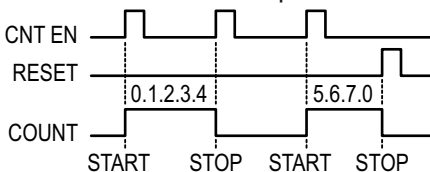

E = 2 Bistable (toggle) **RESET-START/STOP**:

This operating mode is very similar to the one of the \odot key and depends also from t parameter which has 2 possible functioning modes:

E = 2, t = 1 **RESET-START/STOP**:

The first **CNT EN** input impulse resets and starts the timer then, if the second impulse arrives before the end of the count, the timer stops (if the output was enabled now will be disabled), otherwise, if the second impulse arrives after the end of the count, it activates a new counting cycle.

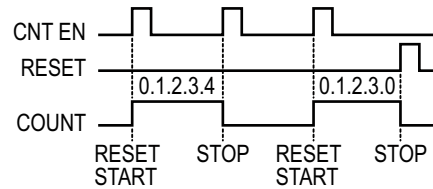

E = 2, t = 2 **RESET/START/STOP**:

At the **first** impulse on **CNT EN** input the timer is **Reset**, at the **second** impulse the counting **Starts**, at the **third** impulse the counting is **stopped**, and so on.

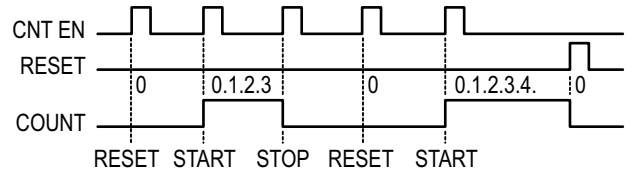

E = 3 Monostable **START/STOP**:

After being reset by means of the **RESET** input, the timer starts when the **CNT EN** contact is closed and stops when the contact is opened. At this point, if the contact is closed again, the count re-starts from the current value and so on until a **RESET** signal is received or the set time period has expired. In this functioning mode the \odot key works only as **RESET**.

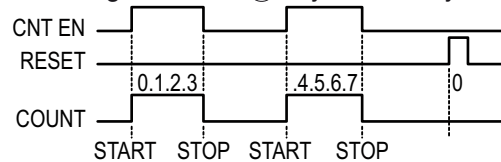

E = 4 Monostable **RESET-START/STOP**:

By closing the **CNT EN** input and keeping it closed, the timer **RESETs** and **STARTs** counting, at the opening of the **CNT EN** input the counting **STOPS**. This operating mode is recommended when the user wants to control the timer using voltage signals. In fact, with an appropriate interface (e.g. an external relay) the timer resets and starts counting when voltage is supplied then stops when voltage is cut off (just like a conventional timer). In this functioning mode the \odot key works only as **RESET**.

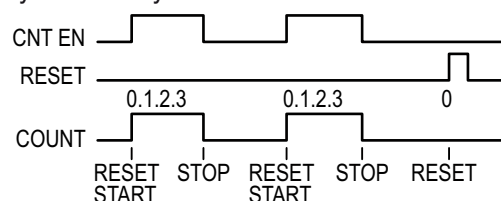

5. PROGRAMMABLE PARAMETERS

5.1 Parameters table

Par.	Description	Range	Def.
1	<i>F1</i> OUT1 operating mode	1 - 2 - 3 - 4 - 5	1
2	<i>F2</i> OUT2 Operating mode	0 - 1 - 2 - 3 - 4	0
3	<i>S1</i> Time Range t_1	1 - 2 - 3 - 4	1
4	<i>S2</i> Time Range t_2	1 - 2 - 3 - 4	1
5	<i>H1</i> Maximum set time t_1	00_ _ ... 99_ _	99_ _
6	<i>H2</i> Maximum set time t_2	00_ _ ... 99_ _	99_ _
7	<i>C</i> Counting mode	1 - 2	1
8	<i>b</i> Back-up mode	1 - 2 - 3	1
9	<i>E</i> CNT EN input operating mode	1 - 2 - 3 - 4	1
10	t $\text{\textcircled{u}}$ key operating mode	0 - 1 - 2 - 3	1

5.2 Parameters description

F 1 **OUT1 Operating mode:**

Allows the user to select the operating mode of **OUT1** output in relation to the count. The 5 modes are:

- 1 = Delayed;
- 2 = Feedthrough;
- 3 = Asymmetrical Oscillator with Start in ON;
- 4 = Asymmetrical Oscillator with Start in OFF;
- 5 = One cycle Asymmetrical Oscillator with Start in OFF.

F 2 **OUT2 Operating mode:**

Allows the user to select the operating mode of **OUT2** output in relation to the count. The 5 modes are:

- 0 = Output disabled;
- 1 = Operates like **OUT1**;
- 2 = ON during counting;
- 3 = Same function as **OUT1** with time t_3 absolute;
- 4 = Same function as **OUT1** with time t_3 relative (dependent) from time t_1 .

S1 **Time range t_1 (and t_3):**

Allows the user to select the range and units of Set time t_1 (and t_3 when active) according to the following options:

- 1 = hours (9999);
- 2 = hours - minutes (99 h 59 min);
- 3 = minutes - seconds (99 min 59 s);
- 4 = seconds - hundredths of a second (99 s. 99 s 1/100).

S2 **TIME RANGE t_2 :**

This parameter only involves the operating modes $F1 = 3$ and 4 and is used to select the time range of the Set time t_2 period. The options are the same as for the $S1$ parameter.

H1 **High set point time t_1 :**

Allows the user to program the max. value of the 2 most significant digits of Set time t_1 .

H2 **High set point time t_2 :**

Similar to **H1** but referred to the Set time t_2 .

C **Counting mode**

Allows to choose the **UP** or **DOWN** counting mode, i.e. whether the display must show the elapsed or the remaining time. The options are:

- 1 = **UP** mode (elapsed time);
- 2 = **DOWN** mode (remaining time).

b **BACK-UP MODE**

This parameter determines the instrument action in the case of power failure. The options are:

- 1 = Timer stops and stores the counting current value;
- 2 = Timer continues counting (only with external battery connected);
- 3 = Timer resets the counting.

When option **1** is selected, the instrument goes OFF and the current counting value is saved. When the power supply is restored, the timer can will start working from the saved value.

When option **2** is selected, in case of power failure the display and the output will go OFF, but the timer will continue counting. Note that mode **2** is enabled only when the external battery is present (see electrical connections). Under these conditions of operation the display is ON but with a brightness lower than in normal mode. We recommend to disable the battery when it is not necessary.

When option **3** is selected, if a power failure happens, the instrument stops the counting and does not store the current counting value, so that when the power supply returns, the instrument will be in the RESET conditions.

E **CNT EN Input operating mode**

This parameter allows to select the operating mode of the Count Enable (**CNT EN**) external input.

The options are:

- 1 = Bistable Start/Stop;
- 2 = Bistable Reset-Start/Stop;
- 3 = Monostable Start/Stop;
- 4 = Monostable Reset-Start/Stop.

t $\text{\textcircled{u}}$ **Key operating mode:**

This parameter permits to decide the operating mode of the $\text{\textcircled{u}}$ key, the possible choices are:

- 0 = Key disabled;
- 1 = RESET-START/STOP;
- 2 = RESET/START/STOP;
- 3 = RESET only.

6. PROBLEMS, MAINTENANCE AND WARRANTY

6.1 Cleaning

It is recommended to clean the instrument only with a cloth wetted with water or with a detergent neither abrasive nor containing solvents.

6.2 Warranty and repairs

The instrument is under warranty against construction vices or defected material, noticed within 18 months from delivery date. The warranty is limited to the repairs or to the substitution of the instrument. The eventual opening of the housing, the violation of the instrument or the wrong use and installation of the product means the automatic decay of the warranty. In case of defected instrument, noticed in warranty period or out of warranty, do contact our sales department to obtain the shipment authorisation.

The defected product must be shipped to Ascon Tecnologic with the detailed description of the failures found and without any fees or charge for Ascon Tecnologic, safe different agreements.

6.3 Disposal

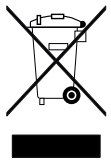

The appliance (or the product) must be disposed of separately in compliance with the local standards in force on waste disposal.

7. TECHNICAL DATA

7.1 Electrical data

Power supply: 12 VDC/VAC, 24, 115, 230 VAC $\pm 10\%$;

Frequency AC: 50/60 Hz;

Power consumption: 2 VA approx.;

Inputs: 2 digital inputs for **Count Enable** (CNT EN) and **Reset** (RES) for voltage-free contacts or voltage signals (the same voltage supply value);

Outputs: Up to 2 outputs:

Relay SPDT (8 A-AC1, 3 A-AC3/250 VAC) or
Voltage output to drive SSR (12VDC/15 mA);

Electrical life for relay outputs: 100000 operations;

Battery for counting without supply: 9 V (form E) external not rechargeable battery;

Consumption with battery supply: 9 mA approx.;

Voltage inputs absorption: 1 mA max.;

Installation category: II

Protection class against electric shock: Class II for Front panel

Insulation: Reinforced insulation between the low voltage section (supply and relay outputs) and the front panel; Reinforced insulation between the low voltage section (supply and relay outputs) and the extra low voltage section (inputs, SSR outputs); Reinforced insulation between the extra low voltage section (SSR outputs) and voltage inputs.

7.2 Mechanical data

Housing: Self-extinguishing plastic, UL 94 V0;

Dimensions: 33 x 75 mm, depth 64 mm;

Weight: 175 g approx.;

Mounting: Flush in panel in 29 x 71 mm hole;

Connections: 2.5 mm² screw terminals block;

Protection degree: IP65 mounted in panel with gasket;

Pollution degree: 2;

Operating temperature: 0... 50°C;

Operating humidity: 30... 95 RH% with no condensation;

Storage temperature: -10... +60°C.

7.3 Functional data

Outputs operating mode: 5 modes for OUT1:

- Delayed,
- Feedthrough,
- Asymmetric times oscillator with start in ON,
- Asymmetric times oscillator with start in OFF,
- One cycle Asymmetrical Oscillator Start OFF;

4 modes for OUT2:

- Like OUT1,
- ON during counting,
- Like OUT1 with time t_{\exists} absolute
- Like OUT1 with time t_{\exists} relative in advance;

Measurement range: 4 time scales: 9999 h, 99 h 59 min, 59 min 59 s, 99 s 99 s/100 (hundreds of second);

Display resolution: According to the scale used: h, min, s, s/100;

Overall accuracy: $\pm 0.1\%$ fs;

Counting autonomy in case of power failure: Depending on battery capacity (e.g. with a 400 mAh full charge battery the autonomy is about 44 hours);

Inputs delay: 15 ms max.;

Display: 4 Digit Red h 12 mm;

Compliance: ECC directive EMC 2004/108/CE (EN 61326);
ECC directive LV 2006/95/CE (EN 61010-1).

8. INSTRUMENT ORDERING CODE

MODEL
TT34 - Timer with mechanical keys

a: POWER SUPPLY
F = 12 VAC/VDC
L = 24 VAC/VDC
H = 100...240 VAC

b: INPUTS
C = Free of voltage contacts
V = Voltage inputs

c: OUT1 OUTPUT
R = Relay output SPDT 8 A-AC1 (for resistive loads)
O = Voltage output to drive SSR (12VDC/15 mA)

d: OUT2 OUTPUT
R = Relay output SPDT 8 A-AC1 (for resistive loads)
O = Voltage output to drive SSR (12VDC/15 mA)
- = Not present

TT34 - a b c d ee

ee: SPECIAL CODES