

Non-programmable signal converters / monitoring relays

Current, voltage, temperature or resistor inputs

Built-in excitation supply for transducer

Current, voltage or relay output

Galvanic separation, supply - input - output

DC supply or AC supply voltages up to 230 VAC

Made in accordance with the **CE** and EMC regulations



The C-mac[®] converters, series L, consists of 3 different basic units, each of them available in a number of variants:

- **LC10** has current input and current, voltage or relay output.
- **LV10** has voltage input and current, voltage or relay output.
- **LM30** has temperature input (3-wire Pt 100) and current, voltage or relay output.
- **LM50** has resistor or potentiometer input and current, voltage or relay output.

The signal converters convert a standard or non-standard analogue input signal to a standard analogue output signal, selectable between 0-20 mA, 4-20 mA, 0-10 V or 2-10 V, and because all units have galvanic isolation between supply, input and output, a safe and effective isolation between the input signals and the equipment, which is connected to the output of the converters, is ensured.

All connections to the converter module are placed on one terminal block, and therefore it is possible to install 2 independent converters in the same housing, thereby reducing the required space in the control panel, where the modules are installed.

Optionally, the converters can be supplied with an input signal monitor with isolated transistor output. This output is only activated, if the input signal is within the specified metering range.

Note:

If the converter is supplied with this monitor, only one converter can be installed in the housing.

The monitoring relays operate with the same input signals, but instead of having an analogue output signal, the modules are supplied with 2 relay outputs, where setpoints and relay functions are user adjustable. All monitoring relays have input signal monitor with transistor output, and only one module can be installed in each housing.

Block diagram, converter unit:

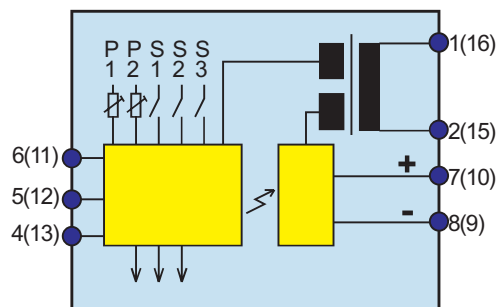

Connections:

- 1-2: supply
- 4: input GND
- 5: input +
- 6: excitation + (LC10 and LV10)
- 6: cable comp. (LM30)
- 7: output +
- 8: output -

Note:

The numbers in brackets refer to unit 2, if 2 converters are installed in the same housing.

Block diagram, input monitor/relay output option:

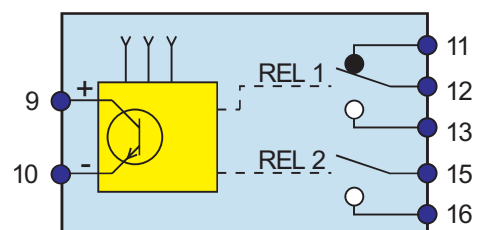

Connections:

- 9: monitor +
- 10: monitor -
- 11: relay 1, NC
- 12: relay 1, com
- 13: relay 1, NO
- 15: relay 2, com
- 16: relay 2, NO

Converters with relay output are always supplied with input signal monitor.

With relay output option, there is no analogue output.

For input monitor option without relay output, connections 12-16 are left open.

Mechanical dimensions:

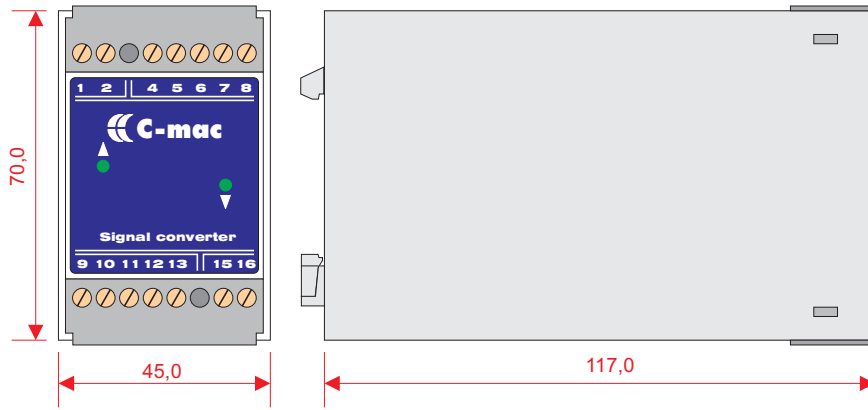

Materials and weight:

Housing base:	CYCOLOY C2100, grey
Frontplate:	CYCOLOY C2100, grey
Terminal cover:	CYCOLOY C2100, black
Terminals:	Zinc-plated brass
Screws:	Zinc-plated iron
Weight:	
with 1 converter:	280 g
with 2 converters:	450 g
relay unit:	350 g

Front view, converter: Note:

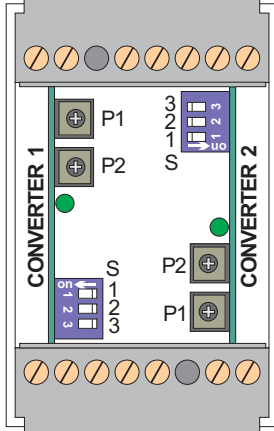

The drawing shows 2 converters in the same housing.

P1: zero adjustment
 P2: span adjustment
 S1 S2 output range
 off off 0 - 20 mA
 off on 4 - 20 mA
 on off 0 - 10 V
 on on 2 - 10 V
 S3 off: factory adjusted
 S3 on: enable fine-adjust

Front view, relays:

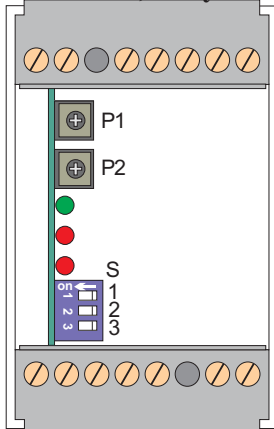

P1: setpoint adjustment 1
 P2: setpoint adjustment 2
 S1, S2: function selection relay 1 and 2:
 off: relay releases, if input signal exceeds the setpoint.
 on: relay activates, if input signal exceeds the setpoint.
 S3: Hysteresis:
 off: 1 %
 on: 5 %

Input connection examples::

Example 1.

External current or voltage source.
 LC10 and LV10, all metering ranges.

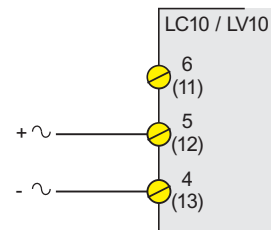

Example 2.

2-wire transducer with current consumption proportional with metering input, e.g. pressure transmitter.
 LC10, 4-20 mA range

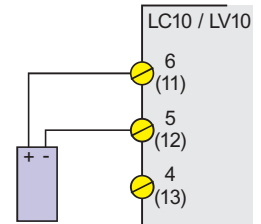

Example 3.

3-wire transducer with current or voltage output.
 LC10, 0-20 mA or 4-20 mA input and LV10, 0-10 V input.
 NOTE: max. current output, pin 6 = 22 mA.

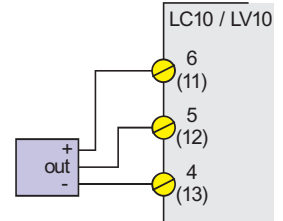

Example 4.

Temperature sensor, 3-wire connection.
 LM30, all metering ranges.

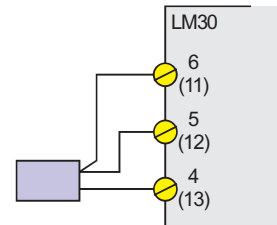

Example 5.

Potentiometer input. (resistor input, connect terminals 5 and 6).
 LM50, all metering ranges.

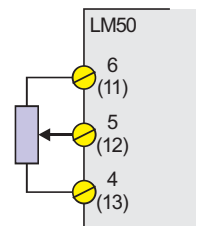

Common technical data:

Supply voltage:	24, 115 and 230 VAC +/- 10%
Supply frequency:	40-70 Hz
Supply voltage DC:	12-50 VDC
Isolation voltages:	Supply - internal electronics: 3.75 kV Input - output: 2.5 kV
Power consumption:	3 VA
Operation temp.:	-20°C to +60°C
Humidity:	0 - 90% RH, non condensing
Temp. coefficient:	< 0,01% /°C
Indications:	
Green LED, activated:	Supply ON and input levels are OK
flashing:	Supply ON and input level error
2 red LED's:	Relay 1 and 2 active (only modules with relay output)

Selections:

Converter modules:	S1-S2: selection of output range S3: enable fine adjustment
Relay modules:	S1-S2: selection of relay function S3: selection of hysteresis

Adjustments:

Converter modules: If S3 is off, the converter is factory adjusted. With S3 on, the adjustments are in accordance with the potentiometer positions.

Potentiometer 1: Fine adjustment of zero point:
LM50: +/- 50% of range
All other units: +/- 5% of range

Potentiometer 2: Fine adjustment of metering range:
LM50: +/- 50% of range
All other units: +/- 5% of range

Relay modules: potentiometer 1: setpoint adjustment, relay 1: 0-100% of range
potentiometer 2: setpoint adjustment, relay 2: 0-100% of range

Exitation output: pin 6, (LC10 and LV10 only)
V_{out}: 24 VDC +5% -20%
I_{out}: max 22 mA

Output ranges, converters:

Range	External load
0 - 20 mA	max. 500 Ω
4 - 20 mA	max. 500 Ω
0 - 10 V	min. 1 kΩ
2 - 10 V	min. 1 kΩ

Max. load relays: 4 A - 250 VAC, ohmic load

Input signal monitor: Transistor output, active if input signal is within the specified metering range, +/- approx. 10%

max. voltage: 30 VDC
max. load: 30 mA

Conversion speed, accuracy and resolution:

type	speed	accuracy	resolution
LC10, AC input	200 msec	2 %	1 %
LC10, DC input	50 msec	1 %	0.5 %
LV10	50 msec	1 %	0.5 %
LM30	50 msec	1 %	0.5 %
LM50	50 msec	1 %	0.5 %

EMC and safety regulations.

Emmision:	EN 50 081 - 1
Immunity:	EN 50 082 - 2
Safety:	EN 60 730

Approvals:

The units are produced in accordance with CE and low voltage directives.

Ordering guide:

aaaa-b-ccc-d

aaaa =	type number
b =	option
ccc =	supply voltage
d =	metering range

type number:

LC10
LV10
LM30
LM50

option:

0 = basic converter, pos. 1
H = converter, pos. 2
R = converter with relay output
M = converter with input monitor

supply voltage:

024 = 24 VAC
115 = 115 VAC
230 = 230 VAC
712 = 12-50 VDC

Metering ranges:

LC 10	LV 10
1 = 0 - 20 mADC	1 = 0 - 60 mVDC
2 = 4 - 20 mADC	2 = 0 - 10 VDC
3 = 0 - 1 AAC	3 = 0 - 250 VAC
4 = 0 - 5 AAC.	4 = 0 - 500 VDC
	5 = 0 - 500 VAC

LM30	LM50
1 = -50 - +150°C	1 = 0 - 100 Ω
2 = 0 - +100°C	2 = 0 - 500 Ω
3 = 0 - +200°C	3 = 0 - 1 k Ω
4 = -50 - + 50 °C	4 = 0 - 5 k Ω
	5 = 0 - 10 k Ω

Ordering examples:

LC10-0-230-2:	Basic current converter, 230 VAC supply, input range 4-20 mA
LV10-0-115-1:	Voltage converter, 115 VAC supply, input range 0-60 mV in position 1.
LC10-H-115-4	Current converter, 115 VAC supply, input range 0-5 AAC in pos. 2 in the same unit.
LM30-M-024-2:	Temperature converter with input monitor, 24 VAC supply, range 0-100°C
LC10-R-230-3:	Current relay, 230 VAC supply, input range 0-1 AAC, 2 relay outputs.

Front view, relay



Front view, converter

